

A	B	C (mm)		D
1	S271-0024	1065	745	1/1
2	S271-0025	1065	745	1/1
3	S271-1014	1089	350	1/1
4	S271-1015	1089	350	1/1
5	S271-1016	1072	275	1/1
6	S271-2015	1518	350	1/1
7	S271-3017	734	275	1/1
8	S271-3018	1486,	330	1/1
9	S271-5032	1016	80	1/1
10	S271-5033	1016	58,	1/1
11	S271-5034	1016	58,	1/1
12	S271-5035	1026	80	1/1
13	S271-5036	1016	80	1/1
14	S271-5038	212,	80,	1/1
15	S271-5039	350	80	1/1
16	S271-5040	350	80	1/1
17	S271-5041	1563	80	1/1
18	S271-5092	1067	38	1/1
19	S271-9005	1091	1496,	1/1

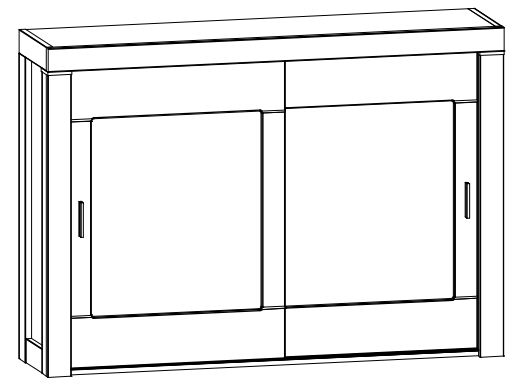

- 2x c429\3
- 16x Ø5x17 mm d1
- 4x M4x22 mm j30
- 2x 62x12/1 mm n52
- 4x Ø75\1
- 1x 5W Ø75\2
- 1x Ø80\3
- 6x Ø3,5x16 mm p25
- 14x s1
- 6x Ø16 s2
- 2x 86x21x15/1,5 n14\2
- 4x Ø3,5x16 mm p38
- 2x Ø10x50 mm f35
- 2x Ø5x60 mm p17



1

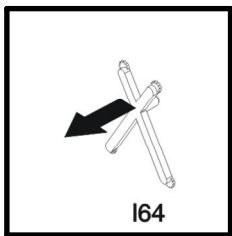
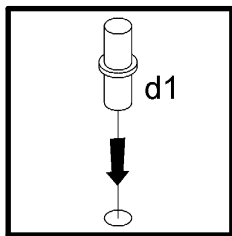
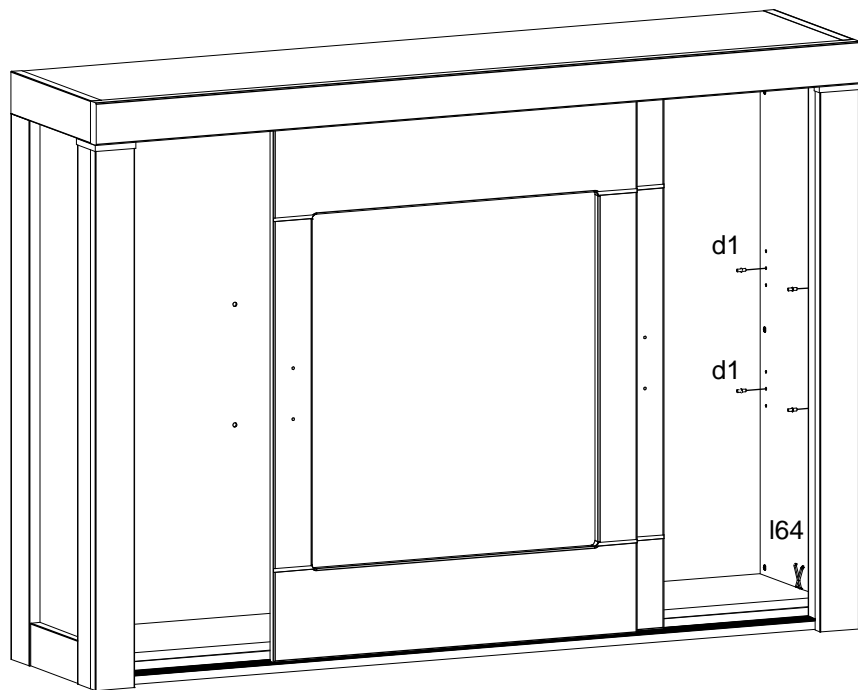

2

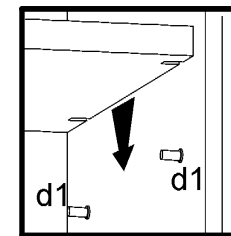
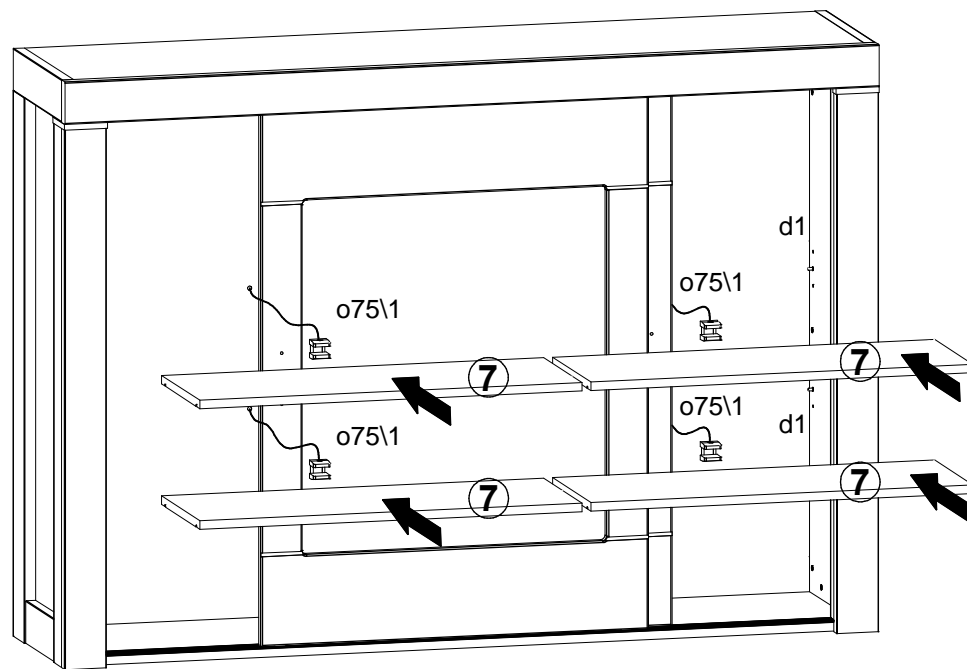

3

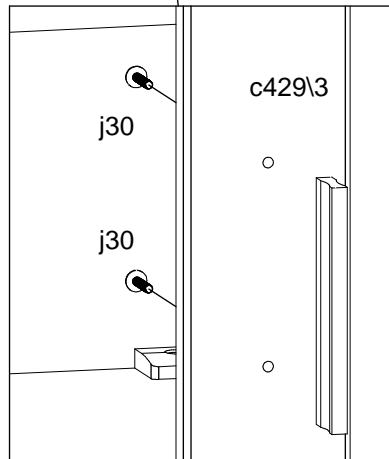
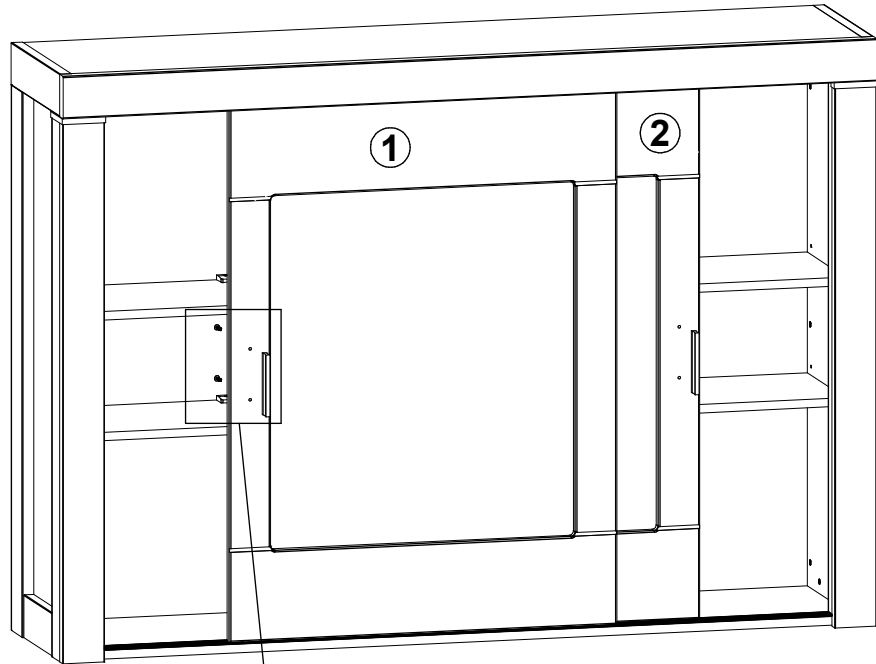
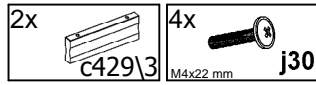

40543W22

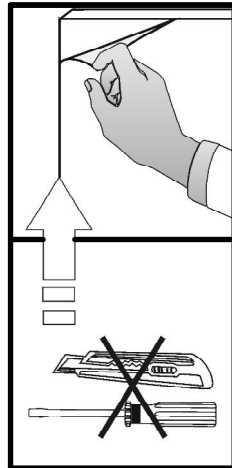

4

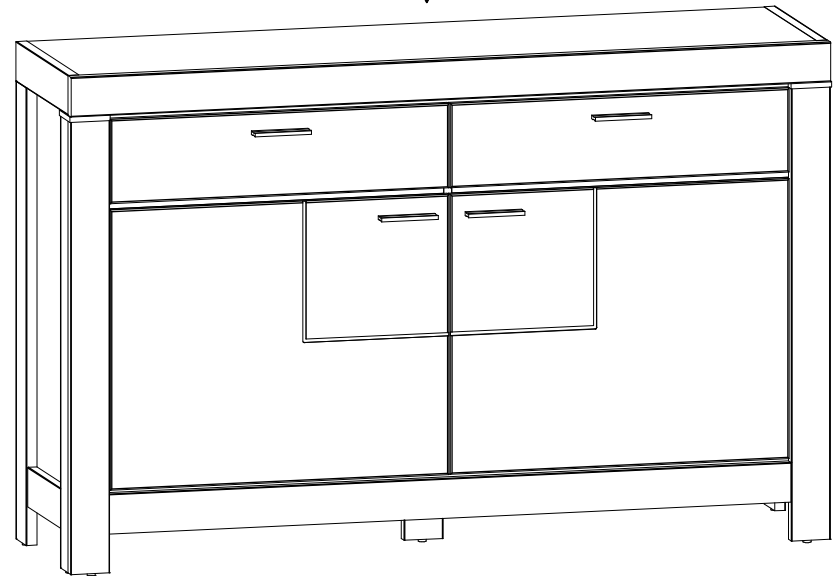
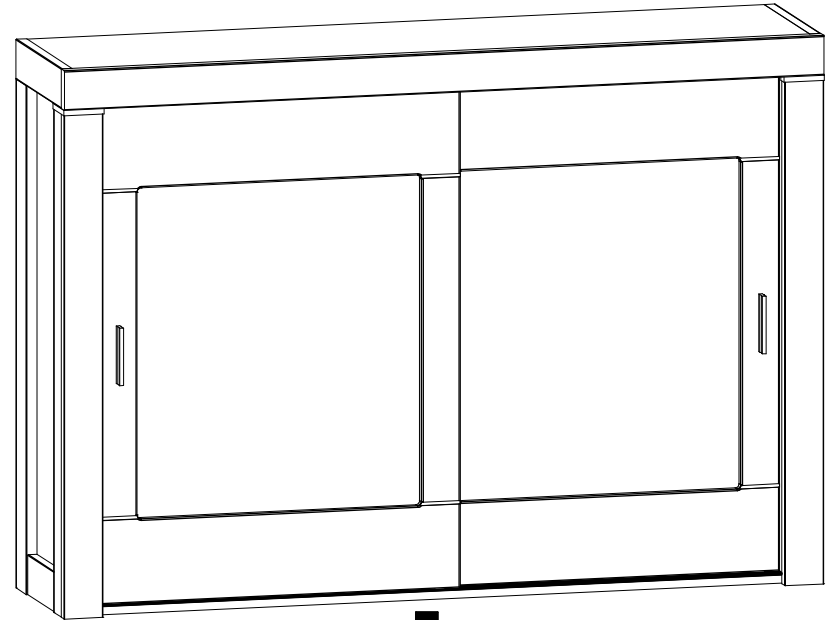

5

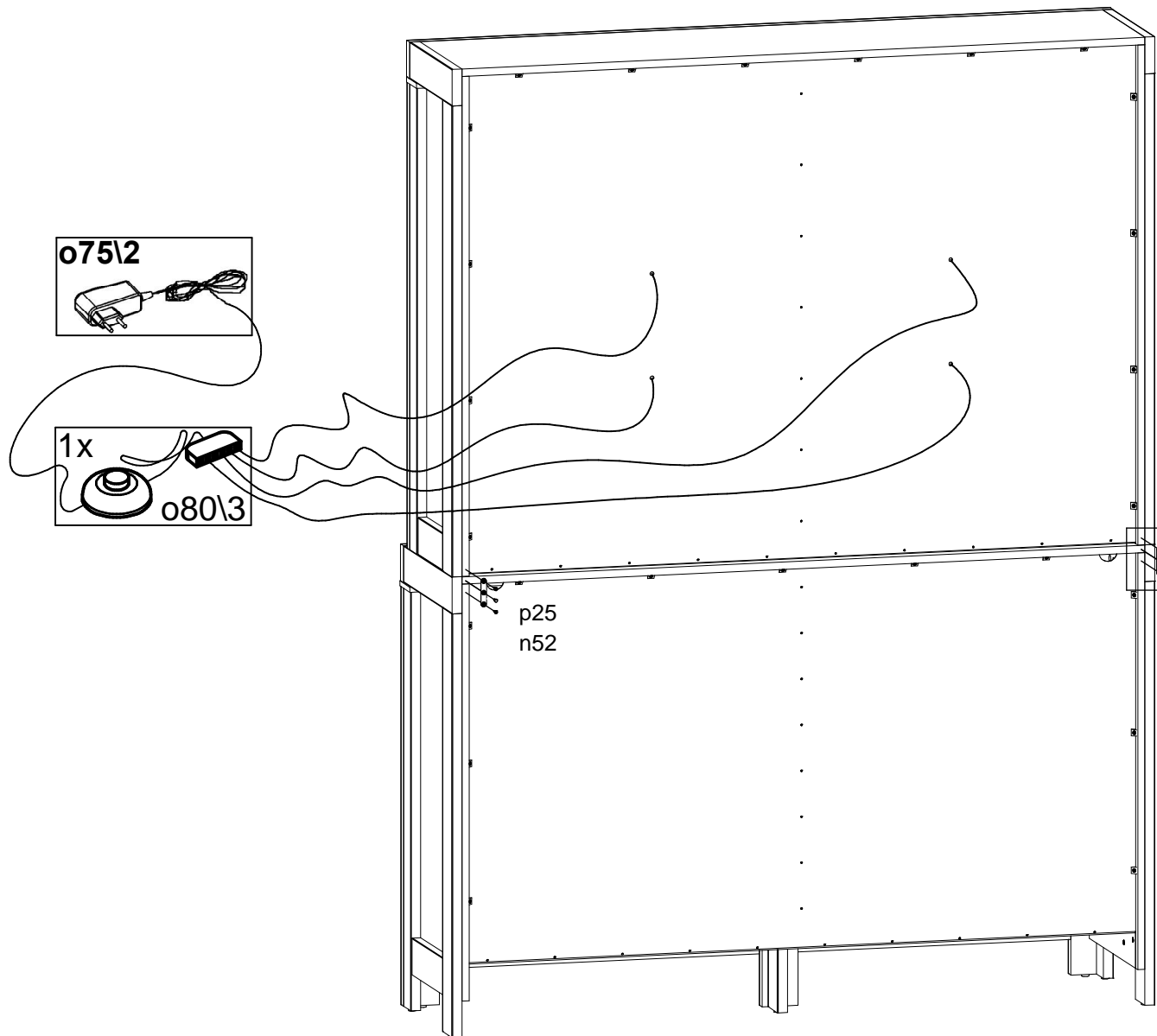
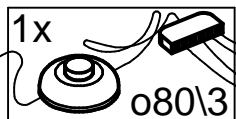
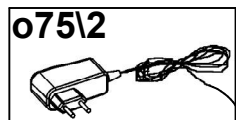
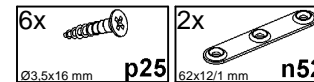
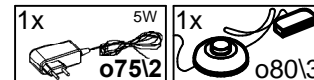

n52  
p25

p25  
n52

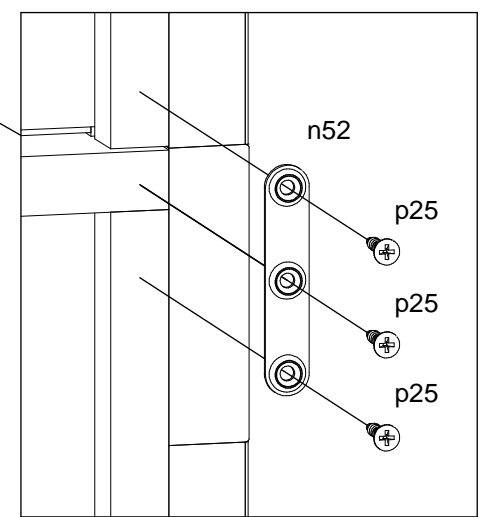

6

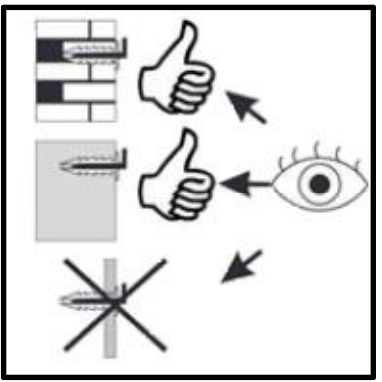
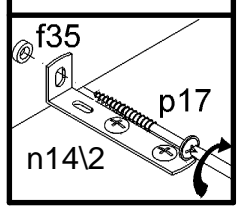
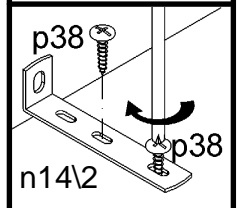
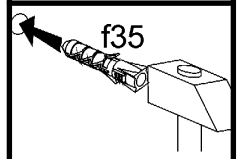
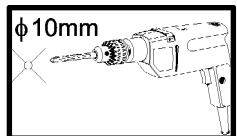
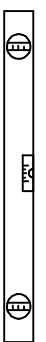
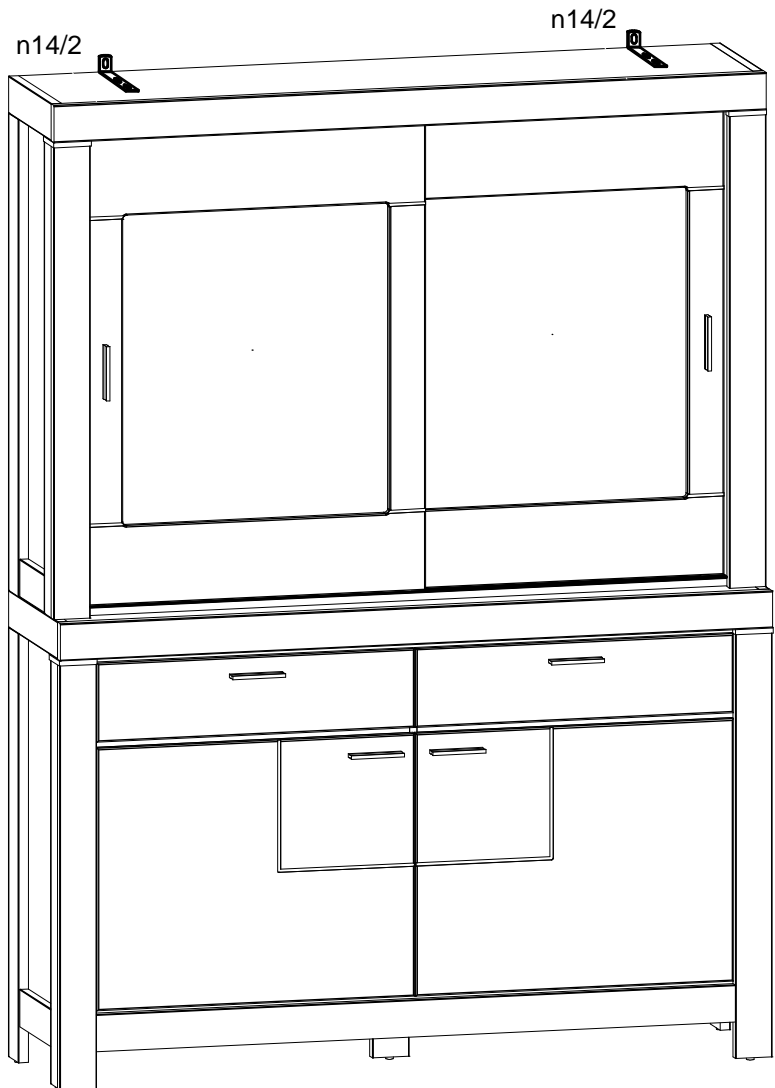
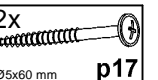
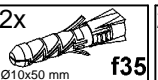
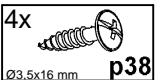
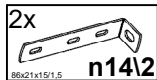

7

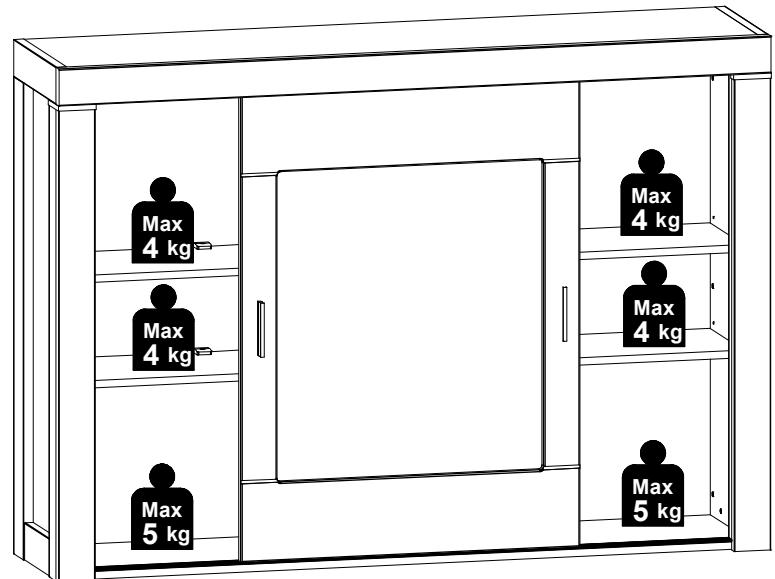

8

